

# MENTEŞELİ SİNEKLİK PROFİLLERİ

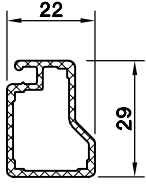

MENTEŞELİ SİNEKLİK PR.  
6799.101

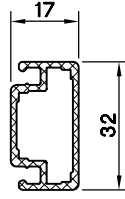

MENTEŞELİ SİNEKLİK ORTAKAYIT PR.  
6799.103

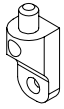

SİNEKLİK MENTEŞESİ  
E799.131

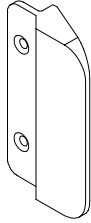

SİNEKLİK TUTAMAĞI  
E799.141

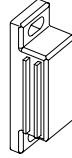

SİNEKLİK ÇİT ÇİT  
H799.111

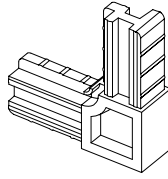
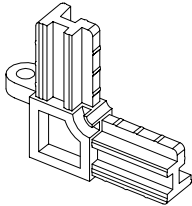
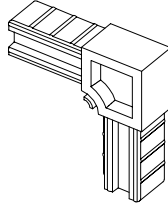
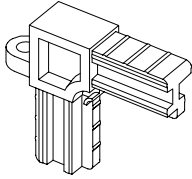
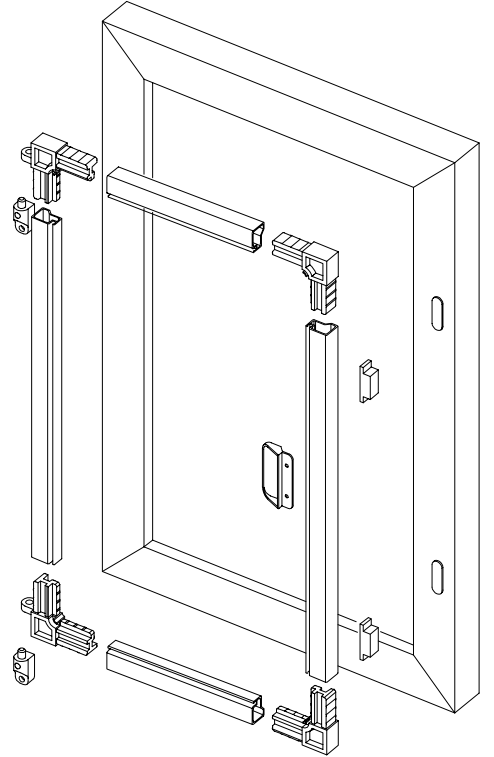

SİNEKLİK KÖŞE BİRLEŞİM PRÇ. (TK)  
E799.121

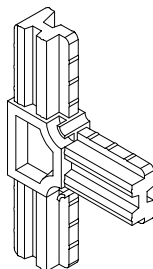
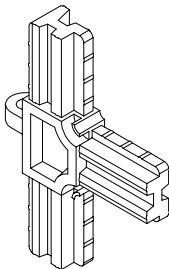

SİNEKLİK ORTAKAYIT BAĞLAMA PRÇ. (TK)  
E799.111

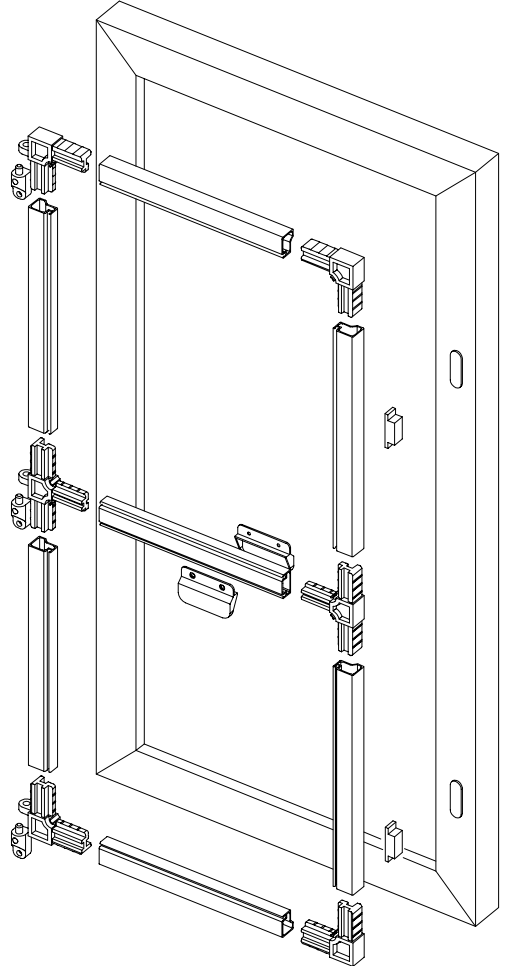

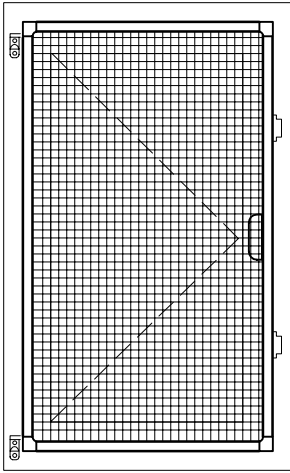
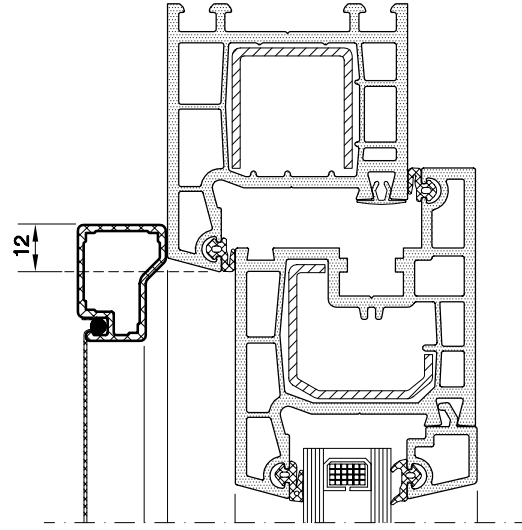
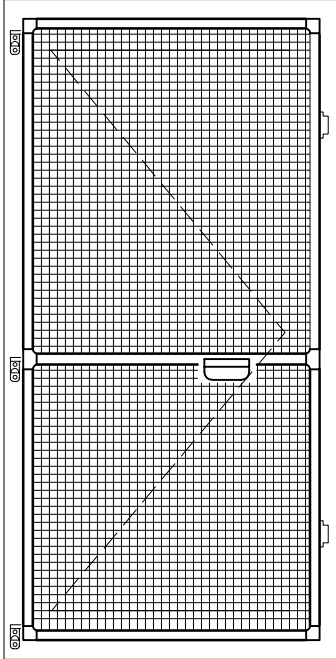
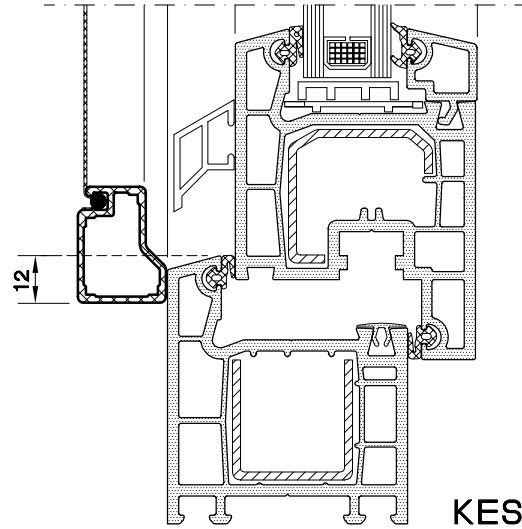
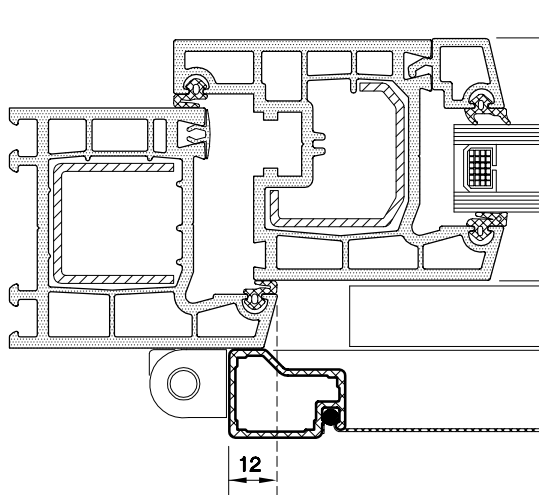
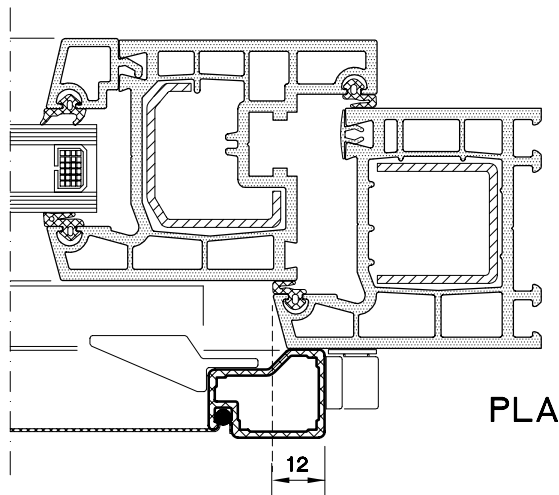
**MENTEŞELİ SİNEKLİK SİSTEM DETAYI****DIŞ GÖRÜNÜŞ****DIŞ****İÇ****DIŞ GÖRÜNÜŞ****KESİT****İÇ****DIŞ****PLAN**

# KİLİTLİ KAPIDA MENTEŞELİ SİNEKLİK SİSTEM DETAYI

**PİMAPEN®**

**S-6000 CLASSIC**

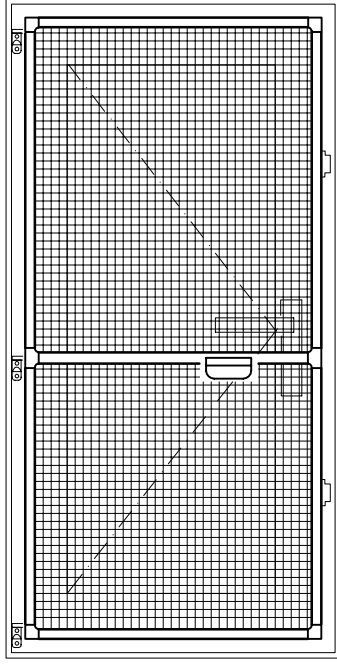

DIŞ GÖRÜNÜŞ

