

ANA PROFİLLER

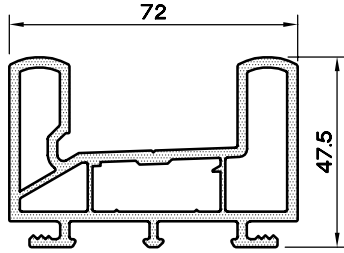

DAR KASA - 72 PROFİLİ
11S3.172

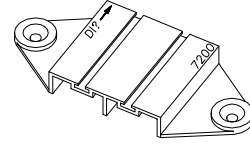

SIZDIRMAZLIK PARÇASI (41)
E5S2.141

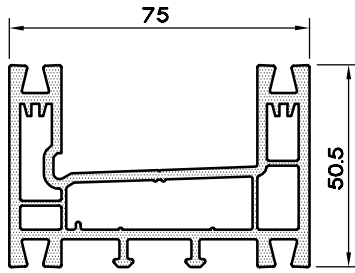

GENİŞ KASA - 75 PROFİLİ
11S1.175

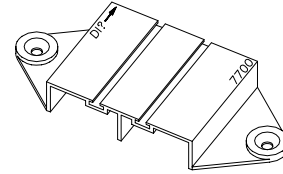

SIZDIRMAZLIK PARÇASI (48)
E5S7.148

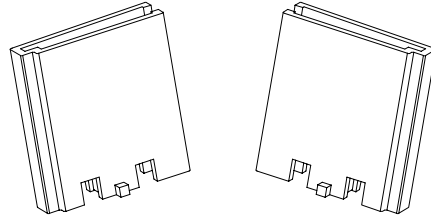

ORTAKAYIT BAĞLAMA PARÇ. TK.
E1S7.521

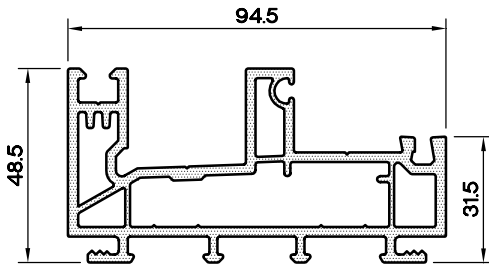

SABİT BÖLMELİ KASA - 95 PROFİLİ
11S2.195

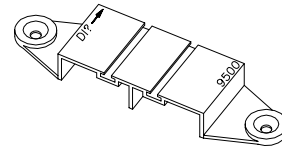

SIZDIRMAZLIK PARÇASI (29)
E5S9.129

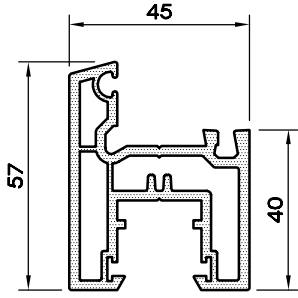
ANA PROFİLLER

DAR KANAT - 45 PROFİLİ
11S3.245

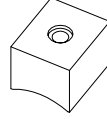

KANAT STOBU
E5S2.211

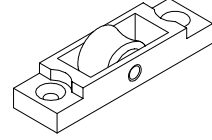

DAR KANAT TEKERLEĞİ
H1S2.111

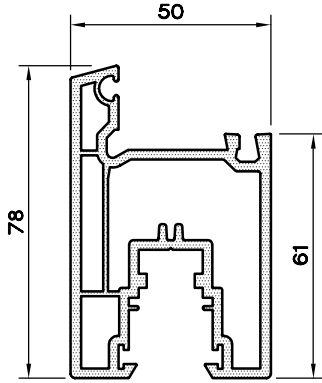

GENİŞ KANAT - 50 PROFİLİ
11S1.250

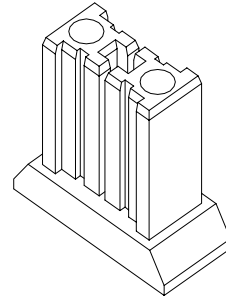

KANAT PR. SABİTLEME PARÇASI
E5S9.011

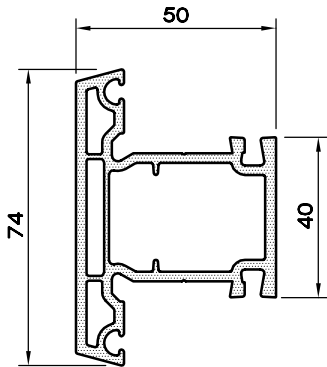

ORTAKAYIT - 74 PROFİLİ
11S1.374

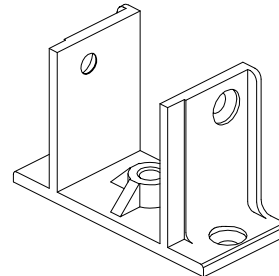

ORTAKAYIT BAĞLAMA PARÇASI
51S7.511